

THIS DRAWING IS UNPUBLISHED. RELEASED FOR PUBLICATION, 19 .
 © COPYRIGHT 19 BY AMP INCORPORATED. ALL INTERNATIONAL RIGHTS RESERVED.

LOC	DIST	P	F	ZONE	LTR	REVISIONS	DATE	APPD
AF	50				G	REV PER 0710-0116-96	7/15/96	JR/PD

1 CONTINUOUS STRIP ON REELS.

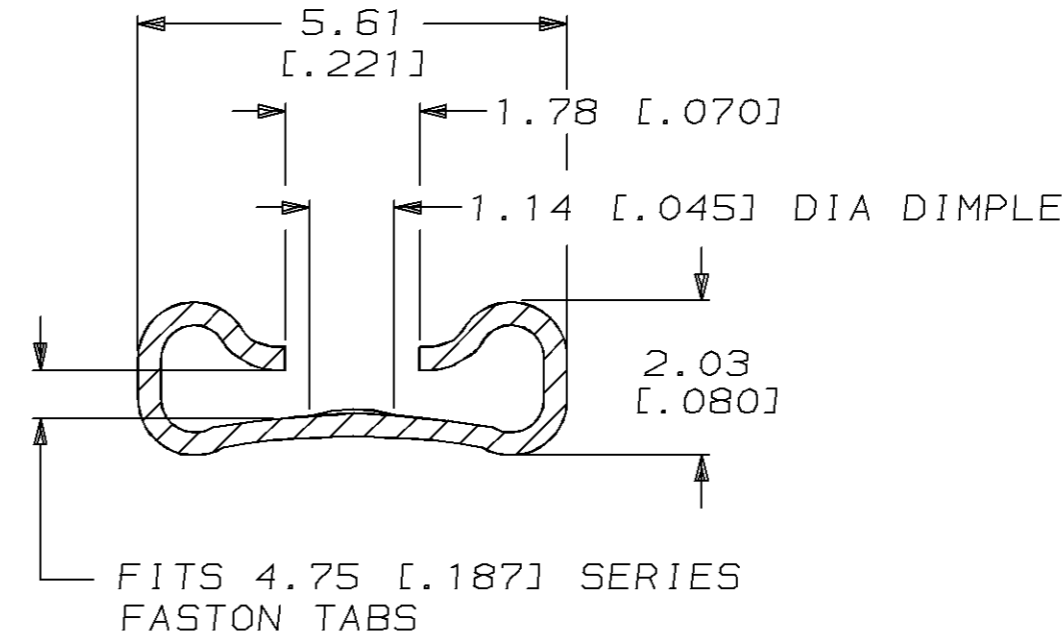
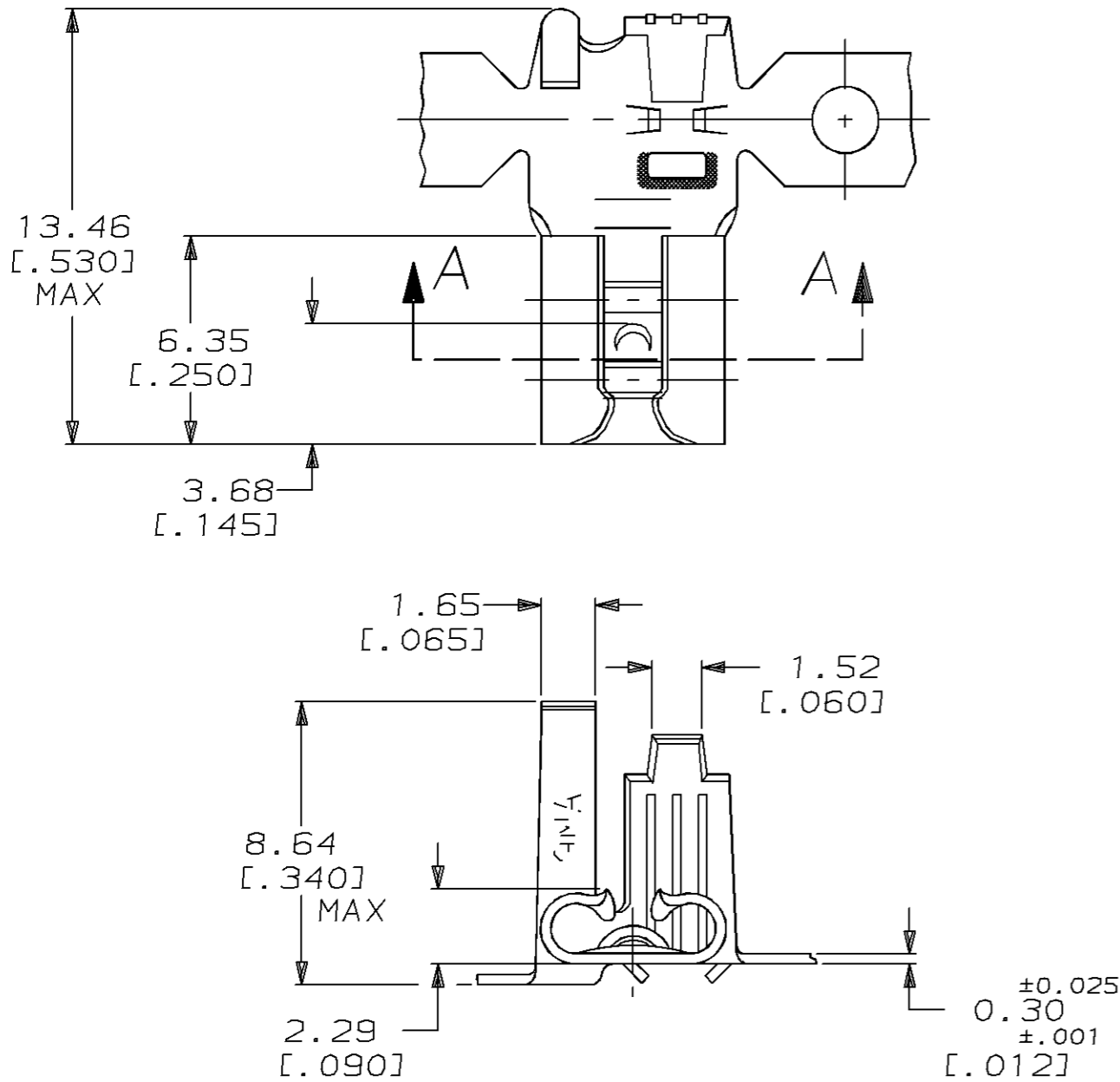

SECTION A-A
SCALE 10:1

METRIC

TIN	2.79-4.32	0.5-1.3mm ²	0.81 [.032]	60529-2
-	[.110-.170] DIA	[20-16] AWG		60529-1
FINISH	INSULATION RANGE	WIRE SIZE	MATING TAB THK ±0.025 [.001]	PART NO
DO NOT SCALE PRINT. UNLESS SPECIFIED DIMENSIONS IN mm [INCHES] TOLERANCES ON: 2 PLC DEC ± 0.25 [.010] 3 PLC DEC ± - ANGLES ± -	DR 11/1/91 JR RUTH CHK 11/1/91 MS FEHER APPD 11/1/91 C MEYERS APPD 11/1/91 D REINER PRODUCT SPEC -	AMP AMP Incorporated Harrisburg, PA 17105-3608 NAME RECEPTACLE, FASTON, 4.75 [.187] SERIES		
MATERIAL H04 BRASS	APPLICATION SPEC -	SIZE B	CAGE CODE 00779	DRAWING NO 60529
FINISH SEE TABLE	WEIGHT -	SCALE 5:1	SHEET 1 OF 1	